



信都電材股份有限公司

HSIN TU ELECTRIC MATERIAL CO., LTD.

427台中市潭子區雅潭路二段292巷11號
42756 No. 11 Lane 292, Yatan Rd., Sec.2, Tantz Dist,
Taichung City, Taiwan, R.O.C.

Tel : +886-4-25314095 Fax : 886-4-25335327

E-mail : sales@hsintu.com

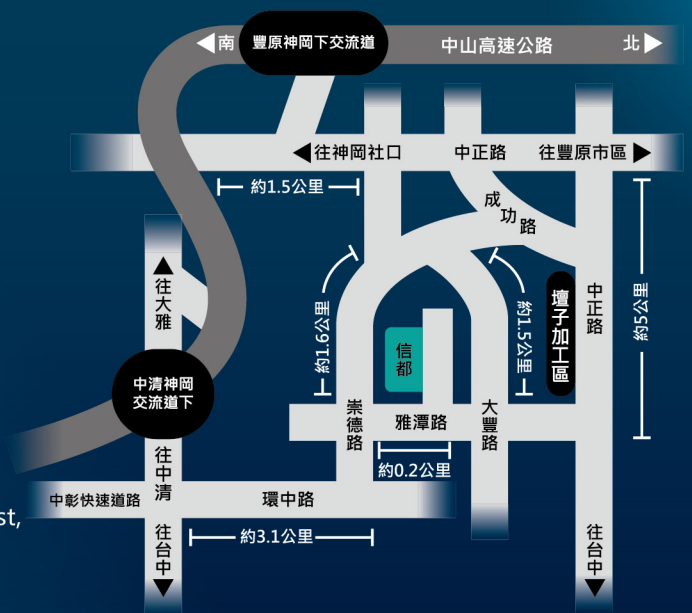



HSIN TU

Manufacture of Electrical, Telecommunication
Medical and Various Custom Cable

www.hsintu.com.tw

Index 目錄

- 02 Company Introduction 公司簡介
- 04 Telecommunication Cable 電信測試線
- 16 Accessories For Telecommunication 電信配件
- 24 Water-Proof Cable Series 防水線材系列
- 28 Medical Cable For Medical Device 醫療專用線材
- 33 Lamp Holder Cable Series 各式燈頭配線組
- 34 DC Cable Series DC 線材系列
- 35 Laptop Inner Cable Series/ Communication Cable Assembly
各式筆記型電腦內部線組 / 通訊線組
- 36 Communication Cable/Coaxial Cable Series 通訊線 / 同軸線加工

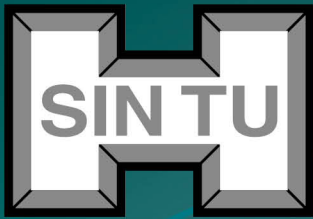

Manufacture of Electrical, Telecommunication, Medical and Various Custom Cables Assembly

AGGRESSIVE | CAUTIOUS | CREATIVE



Aggressive, Cautious, Creative

HSIN TU Company was found in 1984. Based on these years of experience, we have learned to be AGGRESSIVE, CAUTIOUS and CREATIVE. We have earned the trust of our clients and established a good reputation. In order to improve the quality of products, we have invested in the newest equipment and professional R&D team and set up tooling facility to satisfy the needs of our clients.

Our factory has certificated by UL, ISO-9001, ISO-13485 and GMP approval. Plastic material passed biocompatibility ISO 10993-5 and 10993-10 test. We provide OEM and ODM service and all types of wire harness, our product quality and delivery time are always guaranteed.

Specialized Business Range

- Wire sets for computer and electronic products and its peripheral component.
- Various waterproof Communication cable sets and its peripheral component.
- Wire sets for automatic control system and its peripheral component.
- Wire sets for various digital appliance and aviation peripheral component.
- Manufacture of cable communication, telecommunication test set.
- Medical Cable & Wire harness
- Development, design, manufacture and trade for various electronic products and moulds.

公司簡介

信都公司成立 1984 年，累積多年經驗，秉持「積極、嚴謹、創新」的理念，贏得客戶之信賴，建立良好口碑。為持續提高產品品質，特引進相關精密儀器及最專業之研發陣容並成立模具部門，以滿足客戶任何需求，乃本公司一貫政策。

本公司為 UL、ISO 9001、ISO131085 及 GMP 之合格認證廠，並通過 10993-5 及 10993-10 生物相容測試，專營各式特殊配線組合，無論 OEM、ODM 皆能確保品質及交期。

專業項目

- 電子、電腦配線及其週邊零組件。
- 各式防水通訊配線及其週邊零組件。
- 自動控制配線及其週邊零組件。
- 各式數位配線及航空週邊零組件。
- 電信測試專用線材製造。
- 各式醫療配線、醫療儀器配線、航空用配線。
- 各式電子零組件、模具之開發設計、製造加工及貿易。



Telecommunication Cable

電信測試線

Telephone test sets for international and domestic telecommunication office.

P/N:TCC130001

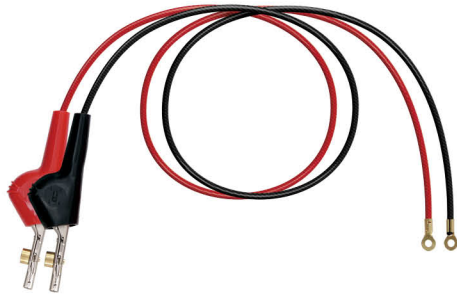

P/N : A9293G	Spec.	P/N : 6C076
ABN with Piercing Pin Clip with Boot	Red/Black Braided Cable	φ 3.6 Ring Terminal
穿刺針夾加護套	紅 / 黑 編織線	φ 3.6 圓型端子

P/N:TCC130002

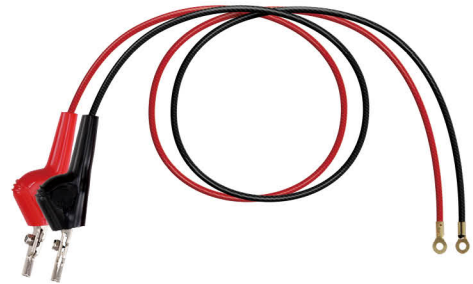

P/N : A9294G	Spec.	P/N : 6C076
Piercing Pin Clip with Boot	Red/Black Braided Cable	φ 3.6 Ring Terminal
穿刺針夾加護套	紅 / 黑 編織線	φ 穿刺針夾加護套

P/N:TCC130003

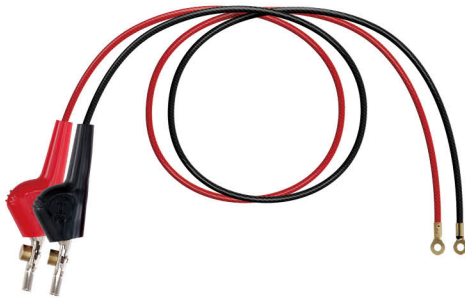

P/N : A9295G	Spec.	P/N : 6C076
ABN only with Boot	Red/Black Braided Cable	φ 3.6 Ring Terminal
ABN 和護套	紅 / 黑 編織線	φ 3.6 圓型端子

P/N:TCC130004



P/N : 6A242	Spec.	P/N : 6A242
RJ45 8P8C HT Plug	Silver 8C Flat Cable	RJ45 8P8C HT Plug
RJ45 8P8C 信部插頭	銀色 8C 扁平線	RJ45 8P8C 信部插頭

P/N:TCC130005



P/N : 6A237	Spec.	P/N : 6A237
RJ11 6P6C HT Plug	Silver 6C Flat Cable	RJ11 6P6C HT Plug
RJ11 6P6C 信部插頭	銀色 6C 扁平線	RJ11 6P6C 信部插頭

P/N:TCC130006



P/N : 6C247G	Spec.	P/N : 6C219G
4 mm Banana Plug	Grey Flat Cable	2.1 mm Pin Plug
4 mm 香蕉插頭	灰色扁平線	2.1 mm 插頭

Telecommunication Cable

P/N: TCC130007



P/N: 6A197	Spec.	P/N: 6C076
6A197 Connector with Alligator Clip	Red/Black Braided Cable	φ 3.6 Ring Terminal
6A197 電信插頭及鱷魚夾	紅 / 黑 編織線	φ 3.6 圓型端子

P/N: TCC130008

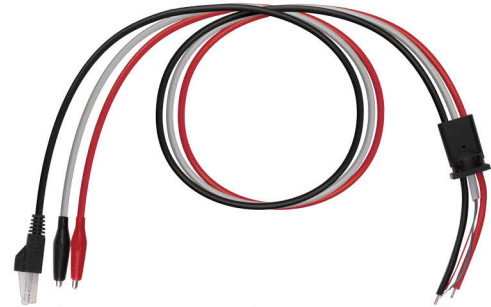

P/N: 57116/54003G	Spec.	Description
RJ11 6P4C Extended Plug with Alligator Clip	Red/Black PVC Cable and Silver Flat Cable	Tinned
RJ11 6P4C 加長型插頭及鱷魚夾	紅 / 黑 PVC 線和銀色扁平線	捲錫

P/N: TCC130009



P/N: 57116/59027G	Spec.	Description
RJ11 6P4C Extended Plug with Alligator Clip	Red/Black PVC Cable and Silver Flat Cable	Tinned
RJ11 6P4C 加長型插頭及鱷魚夾	紅 / 黑 PVC 線和銀色扁平線	捲錫

P/N: TCC130010

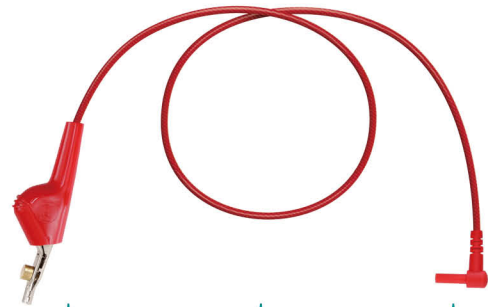

P/N: A9293G	Spec.	P/N: 6C361G
ABN with Piercing Pin Clip with Boot	Red PVC Cable	2 mm Banana Plug
ABN 和穿刺針夾加護套	紅 PVC 線	2 mm 香蕉插頭

P/N: TCC079001



P/N: A9293G	Spec.	P/N: 57045
ABN with Piercing Pin Clip with Boot	Red/Black Braided Cable	RJ11 6P4C Plug
ABN 和穿刺針夾加護套	紅 / 黑 編織線	RJ11 6P4C 插頭

P/N: TCC079002G



P/N: 57057	Spec.	P/N: 57045
Nikel Banana plug	Red/Black Braided Cable	RJ11 6P4C Plug
香蕉插頭	紅 / 黑 編織線	RJ11 6P4C 插頭

P/N:TCC079003



P/N : 54027G	Spec.	P/N : 57045
Alligator Clip with Boot 鱷魚夾加護套	Red/Black Braided Cable 紅 / 黑 編織線	RJ11 6P4C Plug RJ11 6P4C 插頭

P/N:TCC103001

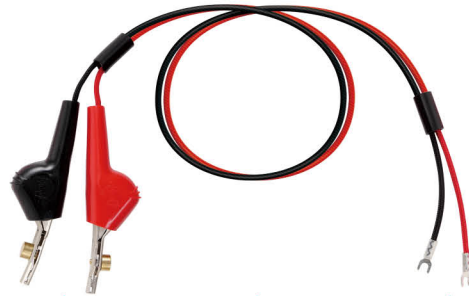

P/N : A9293G	Spec.	P/N : 6C040
ABN with Piercing Pin Clip with Boot ABN 和穿刺針夾加護套	Red/Black Braided Cable 紅 / 黑 編織線	Fork Terminal Y 型端子

P/N:TCC103004

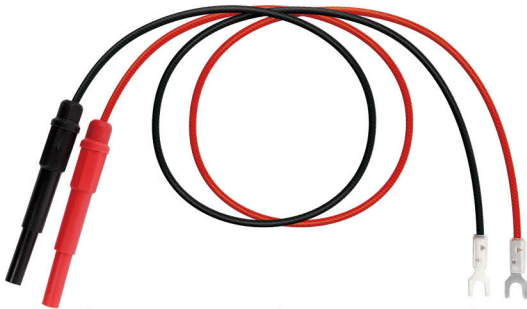

P/N : 6C153	Spec.	P/N : 6C040
Retractable Banana Plug 伸縮式香蕉插頭	Red/Black Braided Cable 紅 / 黑 編織線	Fork Terminal Y 型端子

P/N:TCC103007AG

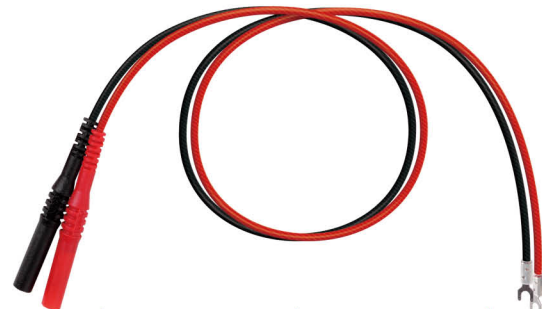

P/N : 6C111	Spec.	P/N : 6C040
Fixed Banana Plug 固定式香蕉插頭	Red/Black Braided Cable 紅 / 黑 編織線	Fork Terminal Y 型端子

P/N:TCC116003G



P/N : A9293G	Spec.	P/N : 57045/6C076
ABN with Piercing Pin Clip with Boot ABN 和穿刺針夾加護套	Red/Black Braided Cable 紅 / 黑 編織線	RJ11 6P4C Plug with ϕ 3.6 Ring Terminal RJ11 6P4C 插頭和 ϕ 3.6 圓型端子



Telecommunication Cable

P/N: TCC116007G



P/N : A9295G	Spec.	P/N : 57057
ABN with Boot ABN 和護套	Green Braided Cable 綠色 編織線	Nikel Banana plug 香蕉插頭

P/N: TCC116007G1

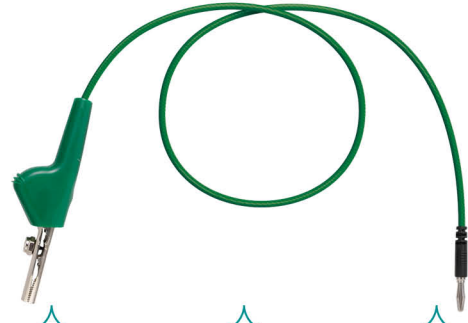

P/N : A9294G	Spec.	P/N : 57057
Piercing Pin Clip With Boot 穿刺針夾加護套	Green Braided Cable 綠色 編織線	Nikel Banana plug 香蕉插頭

P/N: TCC130011



Description	Spec.	Description
Double Banana Plug Connection 雙香蕉插頭	PVC Cable PVC 電子線	Single Banana Plug Breakout 單香蕉插頭

P/N: TCC116015

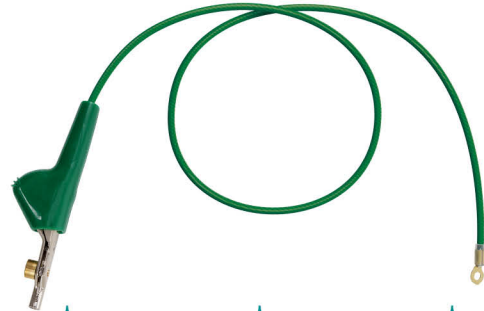

P/N : A9293G	Spec.	P/N : 6C076
ABN with piercing pin clip with Boot ABN 和穿刺針夾加護套	Green Braided Cable 綠色 編織線	φ 3.6 Ring Terminal φ 3.6 圓型端子

P/N: TCC116064



P/N : A9295G/57116	Spec.	Description
RJ11 6P4C Extended Plug with Alligator Clip and Boot RJ11 6P4C 加長型插頭及鱷魚夾加護套	Red/Black PVC Cable and Silver Flat Cable 紅 / 黑 PVC 線和銀色扁平線	Tinned 捲錫

P/N: TCC116025



P/N : 54027G	Spec.	P/N : 6C076
Alligator Clip 鱷魚夾	Red/Black Braided Cable 紅 / 黑 編織線	φ 3.6 Ring Terminal φ 3.6 圓型端子

P/N:TCC116025A



P/N : 54027G	Spec.	P/N : 6C040
Alligator Clip with Boot 鱷魚夾加護套	Red/Black Braided Cable 紅 / 黑 編織線	Fork Terminal Y 型端子

P/N:TCC116027

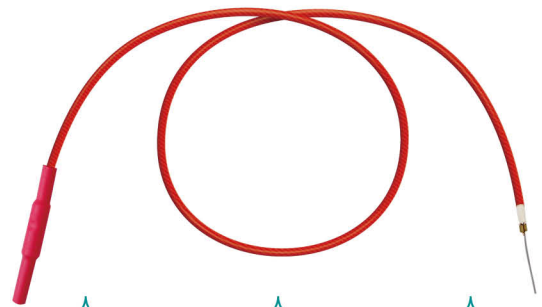

P/N : 6C113	Spec.	Description
φ 1.4 mm Socket φ 1.4 mm 插座	Braided Cable 編織線	Bus Wire 匯排線

P/N:TCC116034G



P/N : 54027G	Spec.	P/N:6A170
Alligator Clip with Boot 鱷魚夾加護套	Red / Black PVC Cable 紅 / 黑 PVC 線	BNC Connector with Long Boot BNC 連接器

P/N:TCC116035G



P/N : A9293G	Spec.	P/N : 6A170
ABN with Piercing Pin Clip with Boot ABN 和穿刺針夾加護套	Red / Black PVC Cable 紅 / 黑 PVC 線	BNC Connector BNC 連接器

P/N:TCC116037G

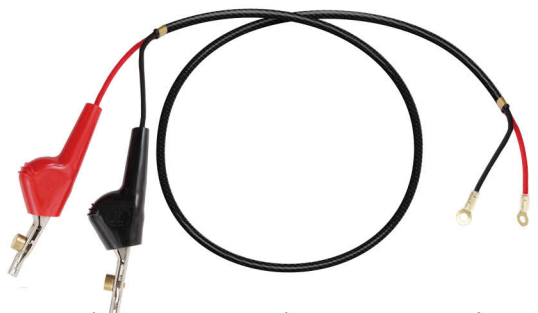

P/N : A9293G	Spec.	P/N : 6C076
ABN with Piercing Pin Clip with Boot ABN 和穿刺針夾加護套	Red / Black with Over Braided Cable 紅 / 黑 編織線	φ 3.6 Ring Terminal φ 3.6 圓型端子

P/N:TCC116039



P/N : 6A170	Spec.	P/N : 57057
BNC Connector BNC 連接器	Red / Black PVC Cable 紅 / 黑 PVC 線	Nikel Banana Plug 香蕉插頭

Telecommunication Cable

P/N: TCC116023



P/N : 6A178	Spec.	P/N : 6C076
346A Male Plug	Red/Black Braided Cable	φ 3.6 Ring Terminal
公端插頭	紅 / 黑 編織線	φ 3.6 圓型端子

P/N: TCC116082



P/N : 6A179	Spec.	P/N : 6C076
471A Female Plug	Red/Black Braided Cable	φ 3.6 Ring Terminal
471A 母端插頭	紅 / 黑 編織線	φ 3.6 圓型端子

P/N: TCC116083

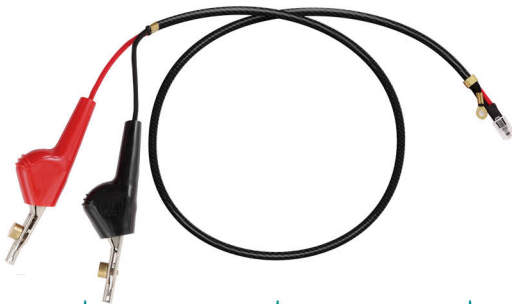

P/N : A9293G	Spec.	P/N : 6A237G/6C076
ABN with Piercing Pin Clip with Boot	Red/Black Braided Cable	RJ11 6P6C HT Plug with Ring Terminal
ABN 和穿刺針夾加護套	紅 / 黑 編織線	RJ11 6P6C 信部插頭和圓型

P/N: TCC116099G

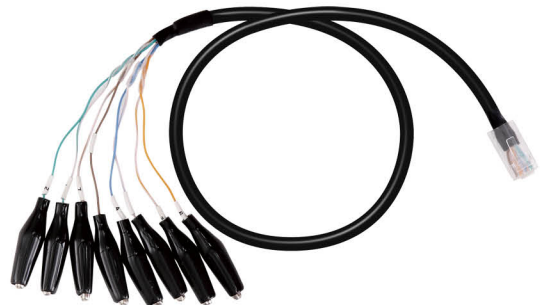

P/N : 54003G	Spec.	P/N : 6A242
Alligator Clip X 8 pcs 鱷魚夾 X 8 pcs	Black PVC 黑 PVC	RJ45 8P8C Plug RJ45 8P8C 插頭

P/N: TCC116105G

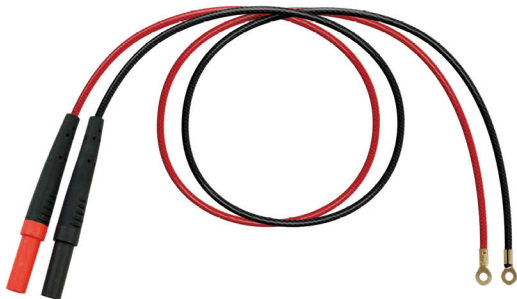

P/N : 6C111	Spec.	P/N : 6C076
Fixed Banana Plug	Red/Black Braided Cable	φ 3.6 Ring Terminal
固定式香蕉插頭	紅 / 黑 編織線	φ 3.6 圓型端子

P/N: TCC116106G

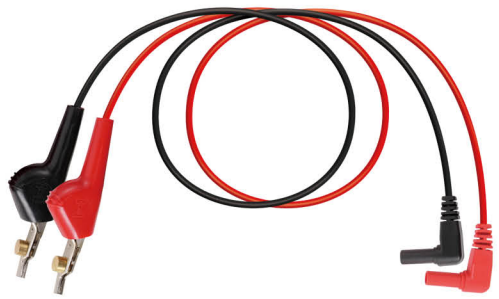

P/N : A9293G	Spec.	P/N : 57315G
ABN with Piercing Pin Clip with Boot	Red / Black PVC Cable	Right Angle Banana plug
ABN 和穿刺針夾加護套	紅 / 黑 PVC 線	直角式香蕉插頭

P/N:TCV201I

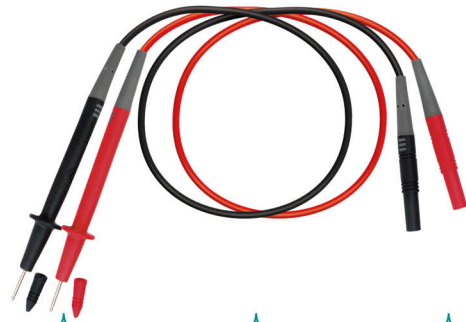

Description	Spec.	Description
2mm Test Probe (18mm)	Red/Black PVC Cable or Silicone Cable	Fixed Straight 4mm Test Plug
2mm 測試棒 (18mm)	紅 / 黑 PVC 線或 矽膠線	4mm 固定直線測試插頭

P/N:TCV229R

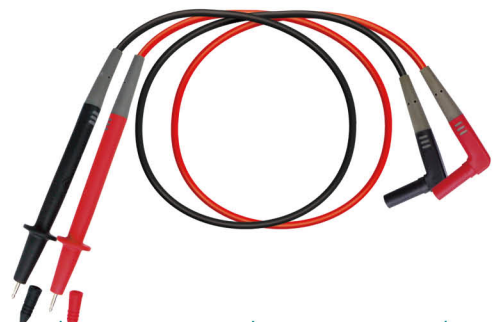

Description	Spec.	Description
2mm Test Probe (4mm)	Red/Black PVC Cable or Silicone Cable	Fixed Right Angle 4mm Test Plug
2mm 測試棒 (4mm)	紅 / 黑 PVC 線或 矽膠線	4mm 固定直角測試插頭

P/N:TCV201R1



Description	Spec.	Description
2mm Test Probe (with M4 screw)	Red/Black PVC Cable or Silicone Cable	Fixed Right Angle 4mm Test Plug
2mm 測試棒 (M4 螺牙)	紅 / 黑 PVC 線或 矽膠線	4mm 固定直角測試插頭

P/N:TCV201I1



Description	Spec.	Description
2mm Test Probe (with M4 screw)	Red/Black PVC Cable or Silicone Cable	Fixed Straight 4mm Test Plug
2mm 測試棒 (M4 螺牙)	紅 / 黑 PVC 線或 矽膠線	4mm 固定直線測試插頭

P/N:TCV201R2

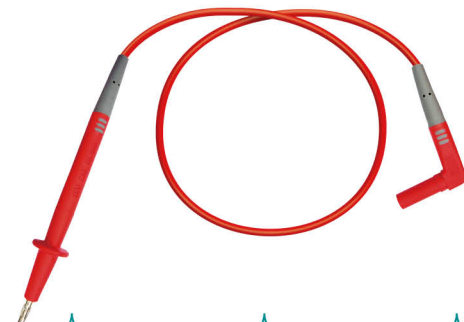

Description	Spec.	Description
4mm Test Probe	Red/Black PVC Cable or Silicone Cable	Fixed Right Angle 4mm Test Plug
4mm 測試棒	紅 / 黑 PVC 線或 矽膠線	4mm 固定直角測試插頭

P/N:TCV201I2

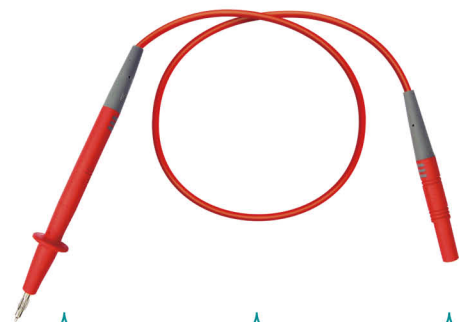

Description	Spec.	Description
4mm Test Probe	Red/Black PVC Cable or Silicone Cable	Fixed Straight 4mm Test Plug
4mm 測試棒	紅 / 黑 PVC 線或 矽膠線	4mm 固定直線測試插頭

Telecommunication Cable

P/N:TCV202I



Description	Spec.	Description
4mm Fixed Straight Plug (10A)	18AWG Red/Black/ Yellow/Blue PVC Cable or Red/Black Silicone Cable	4mm Fixed Straight Plug (10A)
4mm 直線式測試線插頭 (10A)	18AWG 紅 / 黑 / 黃 / 藍 PVC 線或紅 / 黑矽膠線	4mm 直線式測試線插頭 (10A)

P/N:TCV202I1



Description	Spec.	Description
4mm Fixed Straight Plug (25A)	12AWG Red/Black PVC Cable or Silicone Cable	4mm Fixed Straight Plug (25A)
4mm 直線式測試線插頭 (25A)	12AWG 紅 / 黑 PVC 線或矽膠線	4mm 直線式測試線插頭 (25A)

P/N:TCV202R



Description	Spec.	Description
4mm Fixed Right Angle Plug	18AWG Red/Black/ Yellow/Blue PVC Cable or Red/Black Silicone Cable	4mm Fixed Right Angle Plug
4mm 固定直角測試線插頭	18AWG 紅 / 黑 / 黃 / 藍 PVC 線或紅 / 黑矽膠線	4mm 固定直角測試線插頭

P/N:TCV203

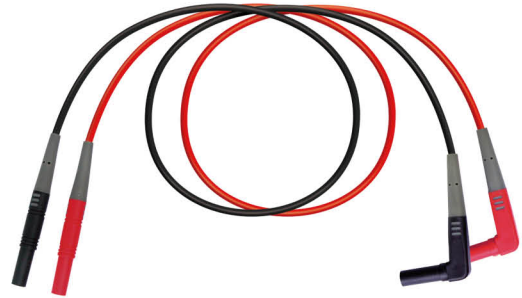

Description	Spec.	Description
4mm Fixed Straight Plug	Red/Black/Yellow/ Blue PVC Cable or Red/Black Silicone Cable	4mm Fixed Right Angle Plug
4mm 直線式測試線插頭	紅 / 黑 / 黃 / 藍 PVC 線或紅 / 黑矽膠線	4mm 固定直角測試線插頭

P/N:TCV204



Description	Spec.	Description
4mm Test Leads with Stackable Plug	Red/Black/Yellow/ Blue PVC Cable or Red/Black Silicone Cable	4mm Test Leads with Stackable Plug
4mm 轉接測試線插頭	紅 / 黑 / 黃 / 藍 PVC 線或紅 / 黑矽膠線	4mm 轉接測試線插頭

P/N:TCV205I



Description	Spec.	Description
Alligator Clip	Red/Black PVC Cable or Silicone Cable	Fixed Straight 4mm Test Plug
鱷魚夾	紅 / 黑 PVC 線或矽膠線	4mm 直線式測試線插頭

P/N:TCV206I



Description	Spec.	Description
Stackable 4mm Fixed Banana Plug	Red/Black/Yellow/Blue PVC Cable or Red/Black Silicone Cable	4mm Fixed Straight Plug
4mm 固定式香蕉插頭	紅 / 黑 / 黃 / 藍 PVC 線或紅 / 黑矽膠線	4mm 固定式直式插頭

P/N:TCV206R



Description	Spec.	Description
Stackable 4mm Fixed Banana Plug	Red/Black/Yellow/Blue PVC Cable or Red/Black Silicone Cable	4mm Fixed Right Angle Plug
4mm 固定式香蕉插頭	紅 / 黑 / 黃 / 藍 PVC 線或紅 / 黑矽膠線	4mm 固定直角式插頭

P/N:TCV209



Description	Spec.	Description
Safety 4mm Straight Banana Plug	Red/Black PVC Cable	Hook Clip (90 mm)
4mm 香蕉式插頭	紅 / 黑 PVC 線	鉤式測試夾 (90mm)

P/N:TCV210



Description	Spec.	Description
Safety 4mm Straight Banana Plug	Red/Black PVC Cable	Hook Clip (54 mm)
4mm 香蕉式插頭	紅 / 黑 PVC 線	鉤式測試夾 (54mm)

P/N:TCV211



Description	Spec.	Description
Safety 4mm Straight Banana Plug	Red/Black PVC Cable	Hook Clip (40 mm)
4mm 香蕉式插頭	紅 / 黑 PVC 線	鉤式測試夾 (40mm)

P/N:TCV212

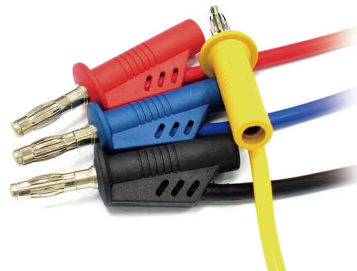

Description	Spec.	Description
4mm Male Banana Plug with 4mm Jack Output	Red/Black/Yellow/Blue PVC Cable or Red/Black Silicone Cable	4mm Male Banana Plug with 4mm Jack Output
4mm 公香蕉插頭	紅 / 黑 / 黃 / 藍 PVC 線或紅 / 黑矽膠線	4mm 公香蕉插頭和 4mm 插座輸出

Telecommunication Cable

P/N: TCV213



Description	Spec.	Description
4mm Male Banana Plug	Red/Black/Yellow/Blue PVC Cable or Red/Black Silicone Cable	4mm Male Banana Plug
4mm 公香蕉插頭	紅 / 黑 / 黃 / 藍 PVC 線或紅 / 黑矽膠線	4mm 公香蕉插頭

P/N: TCV214



Description	Spec.	Description
Safety Straight Banana Plugs (Two Black/Two Red) 直式香蕉插頭兩條	Red/Black PVC Cable 紅 / 黑 PVC 線	Kelvin Clip 凱文夾

P/N: TCV2141



Description	Spec.	Description
Kelvin Clip 凱文夾	Red/Black PVC Cable 紅 / 黑 PVC 線	4mm Male Banana Plugs (two black/two red) 4mm 公香蕉插頭兩條線

P/N: TCV215



Description	Spec.	Description
4mm Straight Banana Plugs (Two Black/Two Red) 4mm 直式香蕉插頭	Red/Black PVC Cable 紅 / 黑 PVC 線	Double Probes 雙插頭

P/N: TCV220

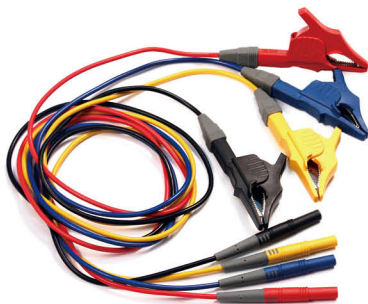

Description	Spec.	Description
Alligator Clip 鱷魚夾	Red/Black/Yellow/Blue PVC Cable or Red/Black Silicone Cable 紅 / 黑 / 黃 / 藍 PVC 線或紅 / 黑矽膠線	4mm Safety Straight Banana Plug 4mm 直式香蕉插頭

P/N: TCV224



Description	Spec.	Description
4mm Plug with 4mm Jack Output 4mm 插頭和 4mm 插座輸出	Red/Black/Yellow/Blue PVC Cable or Red/Black Silicone Cable 紅 / 黑 / 黃 / 藍 PVC 線或紅 / 黑矽膠線	4mm Plug with 4mm Jack Output 4mm 插頭和 4mm 插座輸出

P/N:TCV225

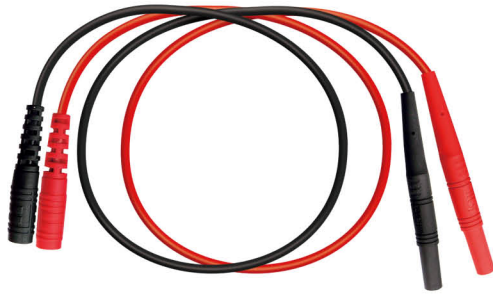

Description	Spec.	Description
4mm Jack Test Lead	Red/Black/Yellow/Blue PVC Cable or Red/Black Silicone Cable	4mm Safety Straight Banana Plug
4mm 插座測試導線	紅 / 黑 / 黃 / 藍 PVC 線或紅 / 黑矽膠線	4mm 直式香蕉插頭

P/N:TCV226



Description	Spec.	Description
Power Cord Lead	Black PVC	Safety 4mm Banana Plug
電源線頭	黑 PVC	4mm 香蕉插頭



Accessories for Telecommunication

P/N: TCA54002G



Spec.

Mini Clip with Boot (Red) (L:31mm)
小鱷魚夾和護套 (紅) (L:31mm)

Description

Open Mouth Length : 8mm
開口長 : 8mm

P/N: TCA54003G



Spec.

Mini Clip with Boot (Black) (L:31mm)
小鱷魚夾和護套 (黑) (L:31mm)

Description

Open Mouth Length : 8mm
開口長 : 8mm

P/N: TCA54005



Spec.

Smaller Clip with Boot (Red) (L:35mm)
中鱷魚夾和護套 (紅) (L:35mm)

Description

Open Mouth Length : 8mm
開口長 : 8mm

P/N: TCA54006



Spec. / 規格

Smaller Clip with Boot (Black) (L:35mm)
中鱷魚夾和護套 (黑) (L:35mm)

Description

Open Mouth Length : 8mm
開口長 : 8mm

P/N: TCA54008



Spec.

Alligator Clip (L:50mm)
鱷魚夾 (L:50mm)

Description

Open Mouth Length : 10mm
開口長 : 10mm

P/N: TCA54009



Spec.

Alligator Clip (L:50mm)
鱷魚夾 (L:50mm)

Description

European and American Standard Alligator Clip
Open Mouth Length: 10mm
歐美規鱷魚夾
開口長 : 10mm

P/N: TCA54027G



Spec.

Alligator Clip (L:50mm)
鱷魚夾 (L:50mm)

Description

Open Mouth Length: 10.3mm
開口長: 10.3mm

P/N: TCA46070 / 071



Spec.

Black/Red Boot for TCA54009 (L:52mm)
黑色鱷魚夾護套用於 TCA54009 (L:52mm)

Description

P/N: TCA46072/073



Spec.

Black/Red Boot for TCA54027G (L:52mm)
黑 / 紅色鱷魚夾護套用於 TCA54027G (L:52mm)

Description

European Standard Boot
(LF) 歐規 鱷魚夾護套

P/N: TCA46087/088



Spec.

Black/Red Boot with Ring for TCA54027G (L:52mm)
黑 / 紅色圓形鱷魚夾護套用於 TCA54027G (L:52mm)

Description

P/N: TCAA9293G



Spec.

ABN with Piercing Pin Clip (L:66.1mm)
ABN 穿刺針夾 (L:66.1mm)

Description

Open Mouth Length: 25.4mm
開口長: 25.4mm

P/N: TCAA9294G

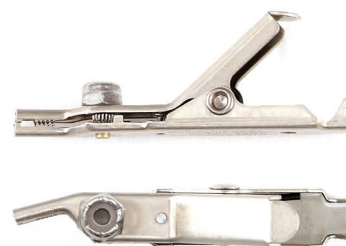

Spec.

Piercing Pin Clip (L:66.1mm)
穿刺針夾 (L:66.1mm)

Description

Open Mouth Length: 25.4mm
開口長: 25.4mm

Accessories for Telecommunication

P/N: TCAA9295G

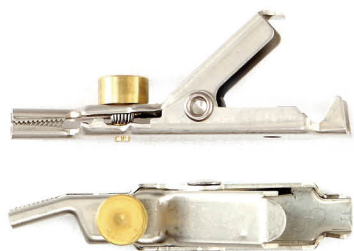

Spec.

Bed of Nail Clip (L:58mm)
釘床 (L:58mm)

Description

Open Mouth Length : 25.4mm
開口長 : 25.4mm

P/N: TCA6A291/292



Spec.

Black/Red Boot for TCAA9293G(L: 61.3mm)
黑 / 紅色鱷魚夾護套用於 TCAA9293G(L: 61.3mm)

Description

Logo : 空白 Blank

P/N: TCA54029G



Spec.

Alligator Clip (Black) 1000 V (L:90mm)
鱷魚夾 (黑) (L:90mm)

Description

Open Mouth Length : 20mm
開口長 : 20mm

P/N: TCA54030G



Spec.

Alligator Clip (Red) 1000V (L:90mm)
鱷魚夾 (紅) (L:90mm)

Description

Open Mouth Length : 20mm
開口長 : 20mm

P/N: TCA54037G



Spec.

300V 15A Mini Red Clip (L:56mm)
300V 15A 紅色小鱷魚夾 (L:56mm)

Description

Open Mouth Length : 12mm
開口長 : 12mm

P/N: TCA54038G



Spec.

300V 15A Mini Black Clip (L:56mm)
300V 15A 黑色小鱷魚夾 (L:56mm)

Description

Open Mouth Length : 12mm
開口長 : 12mm

P/N: TCA54039G

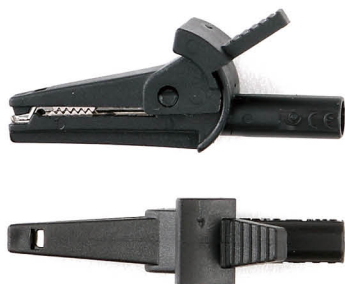

Spec.

600V 10A Mini Black Clip (L:51mm)
600V 10A 黑色小鱷魚夾 (L:51mm)

Description

Open Mouth Length: 12mm
開口長: 12mm

P/N: TCA54040G



Spec.

600V 10A Mini Red Clip (L:51mm)
600V 10A 紅色小鱷魚夾 (L:51mm)

Description

Open Mouth Length: 12mm
開口長: 12mm

P/N: TCAV218



Spec.

4mm Alligator Clip (Red/Black/Yellow/Blue)
4mm 轉接鱷魚夾 (紅 / 黑 / 黃 / 藍)

Description

P/N: TCAAL30C



Spec.

1000V 12A Alligator Clip (Red/Black)
1000V 12A 鱷魚夾 (紅 / 黑)

Description

Total Length: 120mm. Open Mouth Length: 20mm
鱷魚夾總長: 120mm, 開口長: 20mm

P/N: TCAV337



Spec.

2mm Alligator Clip Set (Red/Black)
2mm 轉接鱷魚夾 (紅 / 黑)

Description

IEC/EN 61010-031:2002+A1:2008

P/N: TCAV3371



Spec.

4mm Alligator Clip Set (Red/Black)
4mm 轉接鱷魚夾 (紅 / 黑)

Description

IEC/EN 61010-031:2002+A1:2008

Accessories for Telecommunication

P/N: TCAV3372



Spec.

4mm (M4 Screw) Alligator Clip Set (Red/Black)
4mm M4 螺牙轉接鱷魚夾 (紅/黑)

Description

IEC/EN 61010-031:2002+A1:2008

P/N: TCAV3373



Spec.

2mm Alligator Clip Set (Red/Black)
2mm 轉接鱷魚夾 (紅/黑)

Description

IEC/EN 61010-031:2002+A1:2008

P/N: TCAV3374



Spec.

4mm Alligator Clip Set (Red/Black)
4mm 轉接鱷魚夾 (紅/黑)

Description

IEC/EN 61010-031:2002+A1:2008

P/N: TCAV3375



Spec.

2mm Alligator Clip Set (Red/Black) for TCV229R
2mm 轉接鱷魚夾 (紅/黑) for TCV229R

Description

新式測棒 IEC/EN 61010-031:2002+A1:2008
New Type Clip 新式測棒

P/N: TCA6A237G



Spec.

RJ11 6P6C HT Plug
RJ11 6P6C 信插插頭

Description

MARK:Hsin Tu
Patent is available. 具專利認證

P/N: TCA6A238G



Spec.

RJ45 8P8C HT Plug
RJ11 8P8C 信插插頭

Description

MARK:Hsin Tu
Patent is available. 具專利認證

P/N: TCA57021



Spec.

RJ45 8P8C Plug 3 U" Plated
RJ45 8P8C 插頭鍍 3 U"

P/N: TCA57025



Spec.

RJ11 6P6C Extended Plug 6 U" Plated
RJ11 6P6C 加長型插頭鍍 6 U"

P/N: TCA57045



Spec.

RJ11 6P4C Plug 6 U" Plated
RJ11 6P4C 插頭鍍 6 U"

P/N: TCA57102



Spec.

RJ11 6P4C Plug 50 U" Plated
RJ11 6P4C 插頭鍍 50 U"

P/N: TCA57110



Spec.

RJ11 6P6C Plug 50 U" Plated
RJ11 6P6C 插頭鍍 50 U"

P/N: TCA57116



Spec.

RJ11 6P4C Extended Plug
RJ11 6P4C 加長型插頭

Accessories for Telecommunication

P/N: TCA6A574G



Spec.

Description

Extended Boot for TCA57116 (L: 30 mm)
加長型護套用於 TCA57116 (L: 30 mm)

P/N: TCAV208



Spec.

Description

2mm Test Probe (Red/Black/Yellow/Blue)
2mm 轉接測試棒 (紅 / 黑 / 黃 / 藍)

P/N: TCAV216



Spec.

Description

4mm Safety Socket (Red/Black/Yellow/Blue/Green)
4mm 歐規插座 (紅 / 黑 / 黃 / 藍 / 綠)

1.5mm Pin

P/N: TCAV217



Spec.

Description

4mm Safety Screw-Type Socket
(Red/Black/Yellow/Blue/Green)
4mm 歐規螺牙式插座 (紅 / 黑 / 黃 / 藍 / 綠)

Screw Thread 4mm With 1.5mm Pin
有用螺帽固定. 4mm 輸入端子. 使用螺帽固定. 尾端 4mm 螺牙及 1.5mm PIN

P/N: TCAV223



Spec.

Description

4mm Panel Mount Socket (Red/Black)
4mm 歐規面板式插座 (紅 / 黑)

1.95mm Pin and Screw Fixed
4mm 輸入端子. 使用螺帽固定. 尾端 1.95mm PIN

P/N: TCAV219



Spec.

Description

4mm Flexible Grabber Clip (Red/Black/Green/Blue)
4mm 轉接測試夾 (紅 / 黑 / 藍 / 綠)

P/N: TCAV221



Spec.

Magnetic Contact Adapter Red/Black/Gray
磁性轉接棒 (可彎折)(紅/黑/灰)

Description

Bendable with 4mm Socket and Magnetic Contact
一端磁性接頭·一端4mm母座·可彎折使用

P/N: TCAV222



Spec.

Insulated Adapters (Red/Black/Yellow/Blue)
轉接棒 (紅/黑/黃/藍)

Description

4mm Socket at Both End for Extension
兩端4mm母座·可做轉接延伸使用

P/N: TCAV227



Spec.

4mm Connecting Plug (Red/Black/Yellow/Blue)
4mm 短路連接器 (紅/黑/黃/藍)

Description

P/N: TCAV228



Spec.

4mm Connecting Plug and Bridge
(Red/Black/Yellow/Blue)
4mm 分流連接器 (紅/黑/黃/藍)

Description

Water-Proof Cable Series

防水線材系列

Cable Assembly for Auto-control Device: Suitable for electrical machinery, take transportation car and seafloor diving device or other waterproof equipment.



P/N: HTWBNC CABLE01



BNC Cable End.	Spec.	BNC Cable End.
Male / 公	Insulation Resistance / 絕緣阻抗 5000MΩ Min at DC 500V/60Sec	Female / 母
	Resistance / 電阻 50Ω at 0~4GHz	
	Insulation Voltage / 線材絕緣電壓 1500Vrms Min at DC/60sec	

P/N: HTWCMA01



Cable End.	Spec.	Cable End.
Male / 公	IP Rate / 防水等級 IP67	Female / 母
	Current Rating / 耐電流 3A	
4	Insulation Resistance / 絕緣阻抗 >10MΩ at DC 500V	4
	Resistance / 電阻 <10mΩ	
5	Insulation Voltage / 線材絕緣電壓 AC500V/1 Minute	5

P/N: HTWM801



Cable End.	Spec.	Cable End.
Male / 公	IP Rate / 防水等級 IP67	Female / 母
	Current Rating / 耐電流 3A	
2	Insulation Resistance / 絕緣阻抗 >10MΩ at DC 500V	2
	Resistance / 電阻 <10mΩ	
3	Insulation Voltage / 線材絕緣電壓 AC 500V/1 Minute	3
4		4

P/N: HTWM802



Cable End.	Spec.	Cable End.
Male / 公	IP Rate / 防水等級 IP67	Female / 母
	Current Rating / 耐電流 3A	
2	Insulation Resistance / 絕緣阻抗 >10MΩ at DC 500V	2
	Resistance / 電阻 <10mΩ	
3	Insulation Voltage / 線材絕緣電壓 AC 500V/1 Minute	3
4		4

P/N: HTWM803



Cable End.	Spec.	Cable End.
Male / 公	IP Rate / 防水等級 IP67	Female / 母
	Current Rating / 耐電流 3A	
4	Insulation Resistance / 絕緣阻抗 > 10MΩ at DC 500V	4
	Resistance / 電阻 < 10mΩ	
	Insulation Voltage / 線材絕緣電壓 AC 500V/1 Minute	

P/N: HTWM804



Cable End.	Spec.	Cable End.
Male / 公	IP Rate / 防水等級 IP67	Female / 母
	Current Rating / 耐電流 5A	
2	Insulation Resistance / 絕緣阻抗 > 10MΩ at DC 500V	2
	Resistance / 電阻 < 10mΩ	
3	Insulation Voltage / 線材絕緣電壓 AC500V/1 Minute	3
4		4

Water-Proof Cable Series

P/N: HTWM1201



Cable End.	Spec. / 規格	Cable End.
Male / 公	IP Rate / 防水等級 Current Rating / 耐電流	Female / 母
2	IP67 3A~7A	2
3	Insulation Resistance / 絕緣阻抗 Resistance / 電阻	3
4	>10MΩ at DC 500V <10MΩ	4
6	Insulation Voltage / 線材絕緣電壓	6
	AC500V/1 Minute	

P/N: HTWM1202



Cable End.	Spec.	Cable End.
Male / 公	IP Rate / 防水等級 Current Rating / 耐電流	Female / 母
2	IP67 3A~7A	2
3	Insulation Resistance / 絕緣阻抗 Resistance / 電阻	3
4	>10MΩ at DC 500V <10MΩ	4
6	Insulation Voltage / 線材絕緣電壓	6
	AC500V/1 Minute	

P/N: HTWM1203



Cable End.	Spec.	Cable End.
Male / 公	IP Rate / 防水等級 Current Rating / 耐電流	Female / 母
2	IP67 5A	2
3	Insulation Resistance / 絕緣阻抗 Resistance / 電阻	3
4	>10MΩ at DC 500V <10MΩ	4
5	Insulation Voltage / 線材絕緣電壓	5
	AC500V/1 Minute	

P/N: HTWM1501



Cable End.	Spec. / 規格	Cable End.
Male / 公	IP Rate / 防水等級 Current Rating / 耐電流	Female / 母
2	IP67 3A~7A	2
3	Insulation Resistance / 絕緣阻抗 Resistance / 電阻	3
10	>10MΩ at DC 500V <10MΩ	10
	Insulation Voltage / 線材絕緣電壓	
	AC500V/1 Minute	

P/N: HTWMC01



Cable End.	Spec.	Cable End.
Male / 公	IP Rate / 防水等級 Current Rating / 耐電流	Female / 母
4	IP67 5A	4
6	Insulation Resistance / 絕緣阻抗 Resistance / 電阻	6
	>10MΩ at DC 500V <10MΩ	
	Insulation Voltage / 線材絕緣電壓	
	AC500V/1 Minute	

P/N: HTWMC02



Cable End.	Spec.	Cable End.
Male / 公	IP Rate / 防水等級 Current Rating / 耐電流	Female / 母
4	IP67 5A	4
6	Insulation Resistance / 絕緣阻抗 Resistance / 電阻	6
	>10MΩ at DC 500V <10MΩ	
	Insulation Voltage / 線材絕緣電壓	
	AC500V/1 Minute	

P/N: HTWMN01 #16

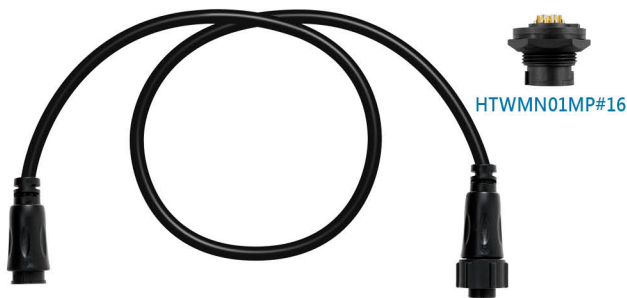

Cable End.	Spec.	Cable End.
Male / 公	IP Rate / 防水等級 Current Rating / 耐電流 Insulation Resistance / 絕緣阻抗 Resistance / 電阻 Insulation Voltage / 線材絕緣電壓	Female / 母
2	IP67 5A >10MΩ at DC 500V <10MΩ AC500V/1 Minute	2
3		3
4		4
5		5

P/N: HTWMN01 #20

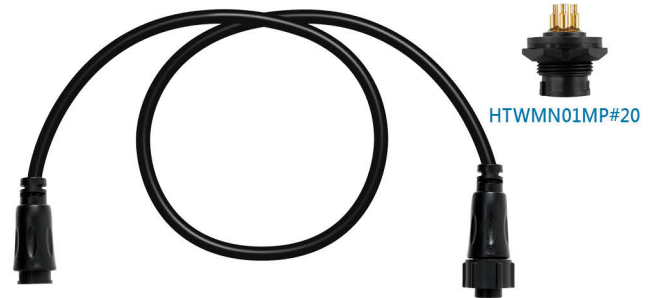

Cable End.	Spec.	Cable End.
Male / 公	IP Rate / 防水等級 Current Rating / 耐電流 Insulation Resistance / 絕緣阻抗 Resistance / 電阻 Insulation Voltage / 線材絕緣電壓	Female / 母
2 6	IP67 5A >10MΩ at DC 500V <10MΩ AC500V/1 Minute	2 6
3 7		3 7
4 8		4 8
5		5

P/N: HTWMN02



Cable End.	Spec.	Cable End.
Male / 公	IP Rate / 防水等級 Current Rating / 耐電流 Insulation Resistance / 絕緣阻抗 Resistance / 電阻 Insulation Voltage / 線材絕緣電壓	Female / 母
4	IP67 5A >10MΩ at DC 500V <10MΩ AC500V/1 Minute	4

P/N: HTWUTS01



Cable End.	Spec.	Cable End.
Male / 公	IP Rate / 防水等級 Current Rating / 耐電流 Insulation Resistance / 絕緣阻抗 Resistance / 電阻 Insulation Voltage / 線材絕緣電壓	Female / 母
15	IP67 5A >10MΩ at DC 500V <10MΩ AC500V/1 Minute	15

P/N: HTWRS01

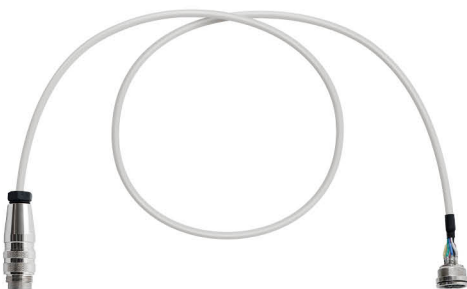

Cable End.	Spec.	Cable End.
Male / 公	IP Rate / 防水等級 Current Rating / 耐電流 Insulation Resistance / 絕緣阻抗 Resistance / 電阻 Insulation Voltage / 線材絕緣電壓	Female / 母
3 6	IP67 3A >10MΩ at DC 500V <10MΩ AC500V/1 Minute	3 6
4 7		4 7
5 8		5 8



The background image shows a medical device with a monitor displaying an ECG waveform. The monitor has several data points: '90', '91', 'REG', '0', 'KAF', and 'KAF'. To the right of the monitor is a control panel with a grid of buttons. Several cables are plugged into the device, and a stethoscope is visible in the foreground. The entire image is overlaid with a blue and teal color scheme and a pattern of thin, curved lines.

Medical Cable For Medical Device

醫療線組

Cable Assembly for Auto-control Device: Suitable for electrical machinery, take transportation car and seafloor diving device or other waterproof equipment.

ECG Cable Series

P/N: MC106005



P/N: 6A307

10P Male Yoke Connector
10P Yoke 公接頭

P/N: 6A318

GE Female for Datex-Ohmeda
Compatible
10P Datex-Ohmeda 相容母接頭

P/N: MC106001

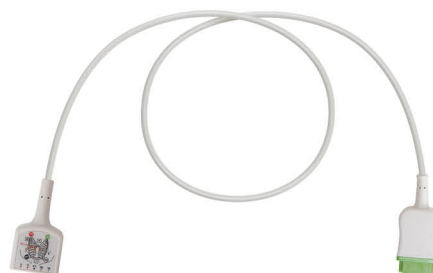

P/N: 6A307

10P Male Yoke Connector
10P Yoke 公接頭

P/N: 6A308

GE Trunk Monitor 11P Female Connector
GH 主幹監控器 11P 母接頭

P/N: MC106007G



P/N: 6A307

10P Male Yoke Connector
10P Yoke 公接頭

P/N: 6A309

11371 6P Male Connector
11371 6P 公膠蕊

P/N: MC106002G



P/N: 6A307

10P Male Yoke Connector
10P Yoke 公接頭

P/N: 6A327

11370 17P Male Connector
11369 17P 公膠蕊

P/N: MC106033



Description

Pinch Connector X 5P
5P 醫療用夾式接頭

P/N: 6A320 X10P

ECG 5-Lead Grabber
5P 夾式線組

P/N: MC106032



Description

Snap Connector X 5P
5P 醫療用鈕扣式接頭

P/N: 6A320 X 10P

ECG 5-Lead Snap
5P 鈕扣式線組

Medical Cable For Medical Device

ECG Cable Series

P/N: MCV164001



Spec.

Philips 3-Lead Shield Snap End 8 Pins Plug, AHA

P/N: MCV164002



Spec.

AAMI 3-Lead Shield Snap End 6 Pins Plug, AHA

P/N: MCV164003



Spec.

ECG Monitor Cable

P/N: MCV164004



Spec.

Philips 3-Lead Shield Snap End 12 Pins Plug, AHA

P/N: MCV164005

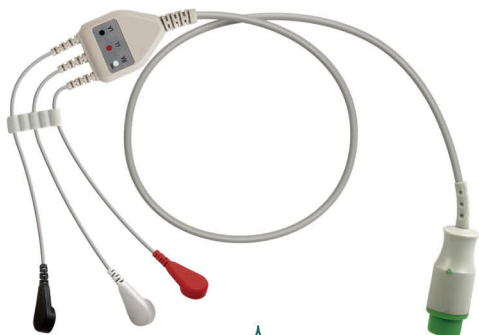

Spec.

Datex 3-Lead Shield Snap End 10 Pins Plug, AHA

P/N: MCV164006



Spec.

Spacelabs 3-Lead Shield Snap End 17 Pins Plug, AHA

SPO2 Cable Series

P/N: MC00412G

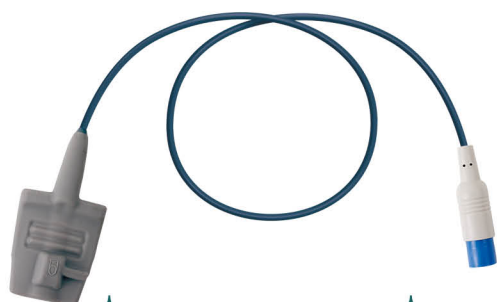

P/N: 6A511G

Silicon SPO2
SPO2 矽膠手指套

P/N: 23970105A

8P Connector For Philip
8P Philip 用接頭

P/N: MC028001G



P/N: 6A352G

SPO2 Clip
SPO2 用醫療夾

P/N: 6A370

DB9 Male Connector
DB9- 公膠蕊

Others

P/N: MC106001G



P/N: 57345G

Lemo FGG : 1B.304.CYCD62Z
Lemo FGG 接頭

Description

Nurse Call for Switch Connector
護士呼叫按鈕

P/N: MC106020



P/N: 6C196G

NTC Temperature Probe
熱敏電阻探針頭

P/N: 57210G

#101CR-2E 6P6C Plug
#101CR-2E 6P6C 插頭

P/N: MC106010



Description

DB9 Female Connector
DB9 母接頭

P/N: 6A166

10P Connector For Space Lab
10 PIN 接頭

P/N: MC106013



P/N: 33VA086002

3M Connector
3M 接頭

Description

DB9 Connector
DB9 接頭

Medical Cable For Medical Device

P/N:MC106009



P/N : 6A172

DO2 12P Male Connector
DO2 12P 公端接頭

Description

DO2 7P Receptacle
DO2 7P 母端接頭

P/N:MC130010



P/N : 57345G

Lemo FGG : 1B.304.CYCD62Z
Lemo FGG 接頭

P/N : 32VB140017G

4P Female Yellow Connector
4P 黃色母接頭

P/N:MC067001G



P/N : A9074

DB9 Adaptor
DB9 轉接頭

P/N:MC6A311



P/N : 6A311

12P Medical Connector
12P 膠蕊

P/N:MC106032



P/N : 32VB140022G

Quick Connector For 2P Female
2P 母端快速接頭

P/N : 32VB140021G

Quick Connector For 2P Male
2P 公端快速接頭



Lamp Holder Cable Series 各式燈頭配線組

Various Lampholder Assembly

Suitable for each kind of inner and outer cable on sewing machines, home electrical instruments and woodworker machines, OEM and ODM are welcome.

適用於各廠牌之縫紉機、家電、木工機之內外部配線，可 OEM、ODM。



DC Cable Series DC 線材系列

DC Cable Harness

Suitable of various harness of peripheral computer, communication and digital camera.

適用於各式電腦週邊、通訊器材週邊及數位相機之配線。



Various Cable Harness in Notebook

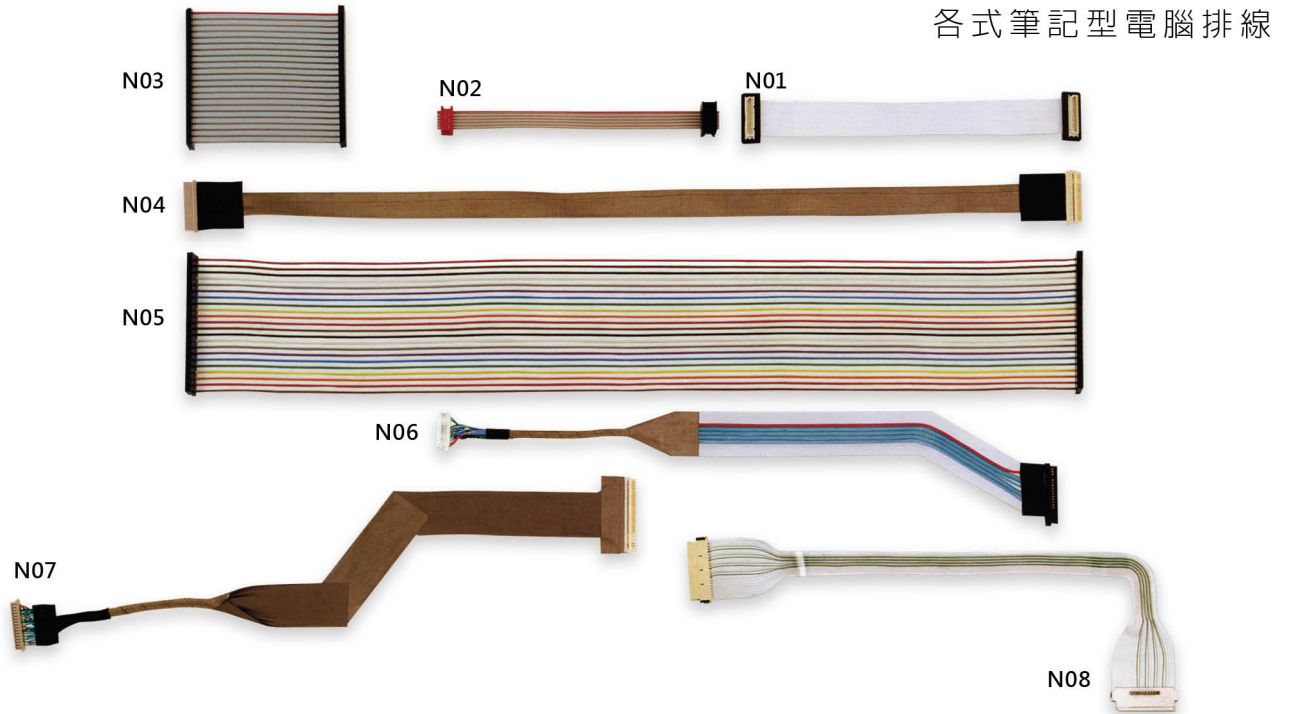

Wire harness of transmission system on computer, auto-control and network device.

電腦、自動控制及網路之傳輸系統所用通訊線組

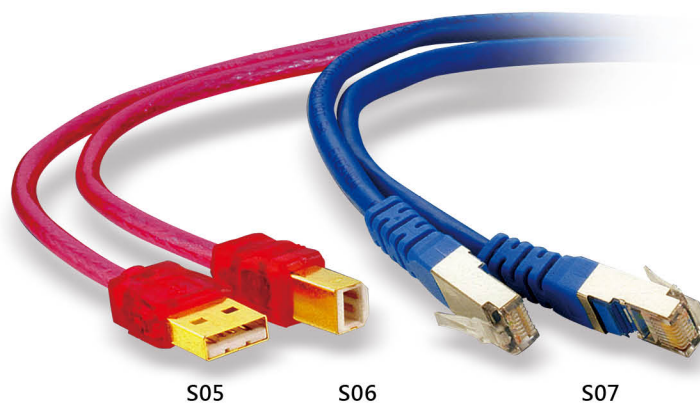
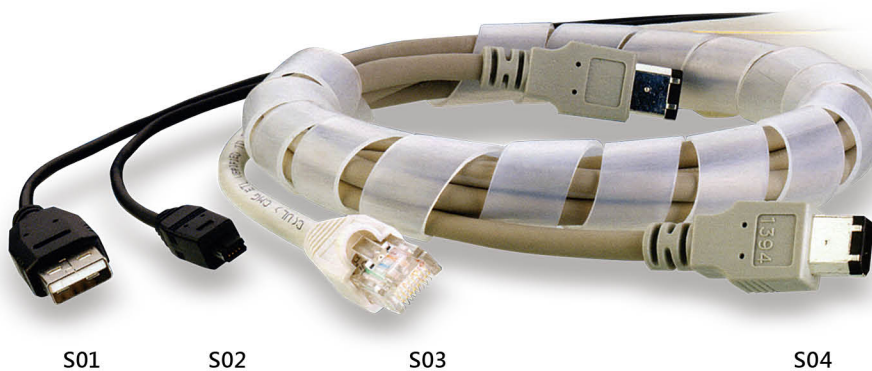

無論國內外各廠牌之連接器，間距自 0.75mm 至 5.08mm，均有多年之加工經驗，尤以 36AWG 至 32AWG 之細線加工技術，更是備受肯定。

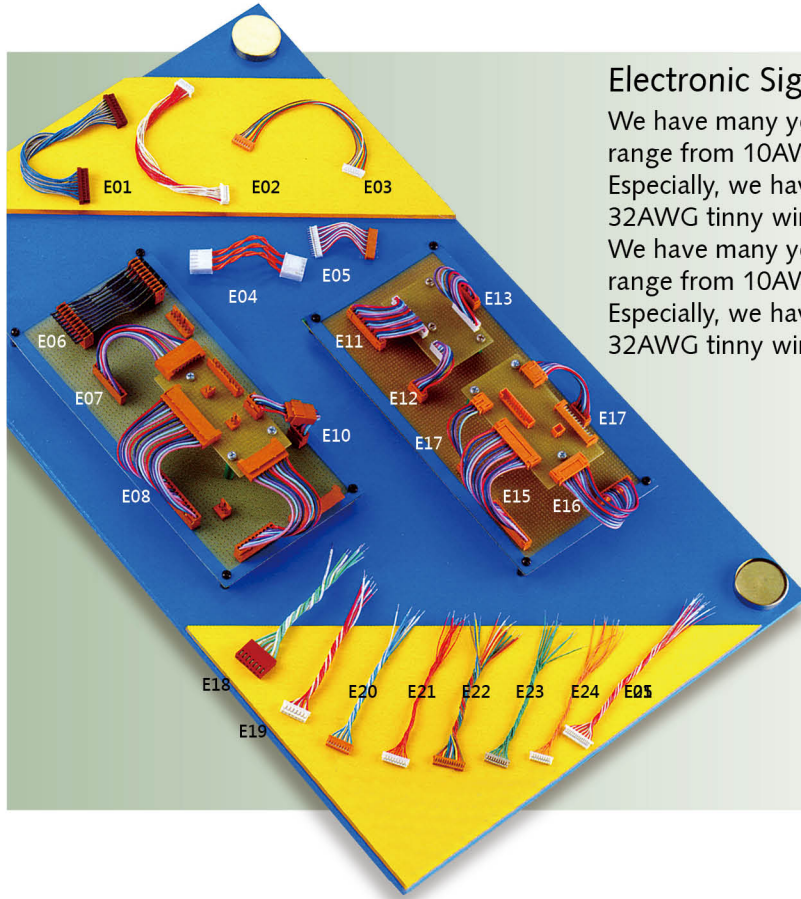

Electronic Signal Cable

We have many years experience in cable assembly and wire range from 10AWG to 36AWG;pitch from 0.75mm to 5.08mm. Especially, we have earned enviable reputation for 36AWG to 32AWG tinny wire assembly.

Electronic Signal Cable
We have many years experience in cable assembly and wire range from 10AWG to 36AWG;pitch from 0.75mm to 5.08mm. Especially, we have earned enviable reputation for 36AWG to 32AWG tinny wire assembly.

Variety of Tiny Coaxial Cable Product

Suitable of communication, computerizing, transportation and satellite device for wireless solution.

各類極細銅軸線材加工製造：適用於通訊、電腦、運輸類...等之無線傳輸。

